

T-LEVELS

THE NEXT LEVEL QUALIFICATION

**SAMPLE
CHAPTER**

BUILDING SERVICES ENGINEERING FOR CONSTRUCTION

Mike Jones
Stephen Jones
Tom Leahy
Peter Tanner
David Warren

CORE

Boost

HODDER
EDUCATION
LEARN MORE

Building Services Engineering for Construction T Level: Core: Boost eBook

The Building Services Engineering for Construction T Level: Core textbook is also available as a Boost eBook. Boost eBooks are interactive, accessible and flexible. They use the latest research and technology to provide the very best experience for students and teachers.

- **Personalise:** eBooks are easy to navigate, with search, zoom and an image gallery. Students can make their own notes, bookmarks and highlights.
- **Revise:** Students can select key facts and definitions to save them as flash cards for quick revision.
- **Listen:** Using text-to-speech the content becomes more accessible to students and improves comprehension and pronunciation.
- **Switch:** Seamlessly move between the printed view for front-of-class teaching and the interactive view for independent study.
- **Download:** Access the eBook offline on any device – in college or at home – with the Boost eBook App.

Building Services Engineering for Construction T Level: Core textbook	9781398332874	£34.00	416 pages Publication: February 2022
Building Services Engineering for Construction T Level: Core Boost eBook	9781398332294	£11.00 (1 year subscription)	416 pages Publication: February 2022

To request free eInspection copies or a free no-obligation digital trial, visit www.hoddereducation.co.uk/construction



T Levels mapping grids

The T Level occupational specialisms are covered by the trade-specific Hodder Education textbooks that you know and trust. We have published mapping grids to demonstrate how these existing textbooks can be used to deliver the following occupational specialisms:

- Electrical and Electronic Equipment Engineering (352)
- Electrotechnical Engineering (353)
- Plumbing Engineering (355)
- Heating Engineering (356)

You can find the mapping grids here: www.hoddereducation.co.uk/subjects/construction/series-pages/t-levels-bse-and-construction

Other new titles from Hodder Education

Look out for our new revision guides for the 8202 suite of qualifications

My Revision Notes: City & Guilds Level 2 Technical Certificate in Plumbing (8202-25)
9781398327351
£14.99

My Revision Notes: City & Guilds Level 2 Technical Certificate in Electrical Installation (8202-20)
9781398327344
£14.99

My Revision Notes: City & Guilds Level 3 Advanced Technical Diploma in Electrical Installation (8202-30)
9781398327337
£15.99

To request free eInspection copies or a free no-obligation digital trial, visit www.hoddereducation.co.uk/construction

Contents

Acknowledgements

About the authors

Guide to the book

Introduction

- 1 Health and safety
- 2 Construction science principles
- 3 Construction design principles
- 4 Construction and the built environment industry
- 5 Sustainability principles
- 6 Measurement principles
- 7 Building technology principles
- 8 Information and data principles
- 9 Relationship management in construction
- 10 Digital technology in construction
- 11 Construction commercial/business principles
- 12 Building services engineering (BSE) systems
- 13 Maintenance principles
- 14 Tools, equipment and materials

About the exams and employer-set project

Answers

Glossary

Index

Guide to the book

The following features can be found in this book.

Learning outcomes

Core knowledge outcomes that you must understand and learn.

Health and safety

Important points to ensure safety in the workplace.

Key terms

Important terms that you should understand.

Improve your maths

Short activities that encourage you to apply and develop your functional maths skills, in context.

Industry tips

Useful tips and advice to help you in the workplace.

Improve your English

Short activities that encourage you to apply and develop your functional English skills, in context.

Research

Research-based activities – either stretch and challenge activities, enabling you to go beyond the course, or industry placement-based activities encouraging you to discover more about your placement.

Assessment practice

Knowledge-based practice questions to help prepare you for the exam.

Case study

Placing knowledge into a fictionalised, real-life context. Useful to introduce problem solving and dilemmas.

Project practice

Short scenarios and focused activities, reflecting one or more of the tasks that you will need to undertake during completion of the employer-set project.

Test yourself

A knowledge consolidation feature containing questions and tasks to aid understanding and guide you to think about a topic in detail.

Chapter 3 Construction design principles

Introduction

This chapter compares modern and traditional building methods, and investigates how good design can reduce the impact of construction work on the wider environment. It considers how modern building methods can reduce project durations, lower costs and improve the health and safety of workers by manufacturing off site.

It then explores the role of different disciplines in the design process from conception to completion, together with factors that influence the design of a building project.

Learning outcomes

By the end of this chapter, you will understand:

- 1 the benefits of good design
- 2 design principles
- 3 the role of different disciplines involved in design
- 4 the design process from conception to completion
- 5 the concept of the 'whole building', including life cycle assessment.

1 Benefits of good design

1.1 Factors of good design

Design function

Before choosing a method of construction, it is important to understand how the building will achieve its design function. All buildings are initially designed to meet the client's specification because without them to finance the work, there is no project. However, sometimes the needs of the client have to be compromised to satisfy local restrictions, planning laws, building regulations and environmental requirements. In addition, designers often have to consider:

- ▶ the aesthetics of the building and how it will fit into its proposed environment
- ▶ access and egress
- ▶ security
- ▶ internal layout and arrangement of rooms/spaces
- ▶ energy efficiency.

Once these aspects have been determined, designers and clients must decide what form of construction to use for the **superstructure** of the building. There are several important factors to consider when selecting a method of construction, for example, build speed, familiarity with the building system and cost.

Key term

Superstructure: the part of a building above ground level, built on the basement or foundation

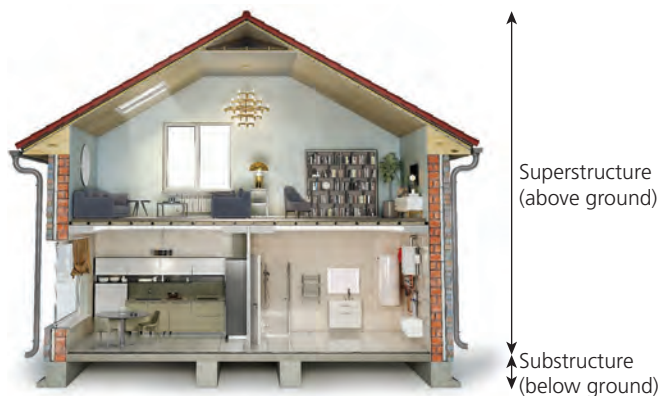

▲ Figure 3.1 Superstructure and substructure of a building

By contrast, the substructure of a building is the part below ground level. For more information on superstructure and substructure, see Chapter 7.

Environmental impact

The way we construct and use buildings for all types of purpose will have an impact on the environment. However, with considerate planning and the use of modern and innovative building materials, this impact can be minimised.

Without tight monitoring systems and control measures, construction work on **greenfield sites** and other types of land such as conservation areas may result in damage or destruction of natural wildlife habitats. (There is further information on greenfield and **brownfield sites** in section 1.3 of this chapter.)

Inconsiderate construction and inappropriate disposal of waste materials can lead to pollution of the land, the air and natural water courses, such as streams, rivers and lakes. This can damage or destroy whole ecosystems, outside the boundary of the site and beyond the lifetime of the development.

Key terms

Greenfield sites: areas of land that have not been previously developed or built on, above or below ground

Brownfield sites: areas of land that have been previously developed or built on, even if there is no physical evidence of earlier use



▲ Figure 3.2 A greenfield site



▲ Figure 3.3 A brownfield site

The environmental impact of a building's design, construction and use is controlled and monitored by:

- ▶ an environmental impact assessment (EIA)
- ▶ an energy performance certificate (EPC)
- ▶ the Code for Sustainable Homes
- ▶ a site waste management plan (SWMP)
- ▶ building regulations (Part L).

Environmental impact assessment (EIA)

The Town and Country Planning (Environmental Impact Assessment) Regulations 2017 require developers to identify significant effects on the environment of their proposed construction project at the planning application stage. If the type of development is listed in Schedule 2 of the regulations and exceeds the thresholds set out there, the local authority must screen the proposals to determine the likely environmental impact and decide whether an EIA is required. This also allows the public an early opportunity to be involved with decision-making procedures.

The regulations affect only a small proportion of private and public projects that require planning permission; however, they could also apply to some **permitted development**.

Key term

Permitted development: building work that does not require planning permission from the local authority but must still be constructed according to building regulations

Research

Search online for 'Schedule 3 of The Town and Country Planning (Environmental Impact Assessment) Regulations 2017'. You can access it here: www.legislation.gov.uk/ukxi/2017/571/schedule/3/made

Use the screening criteria to determine the environmental impact of construction work you have recently been involved in.

Energy performance certificate (EPC)

EPCs are a legal requirement for domestic and commercial properties in the UK that are available to buy or rent. However, some buildings may be exempt, for example, residential buildings that are intended to be used for less than four months a year and listed buildings.

To obtain an EPC, an accredited assessor must evaluate the energy efficiency of a building. They will check that loft and wall insulation has been correctly installed, and they will review records of energy use (also referred to as heat demand) for the past two years. Once satisfied, they will award an energy efficiency rating from A (most efficient) to G (least efficient) and a certificate containing information about the property's energy use and average energy costs. The certificate may also make recommendations about how to reduce energy use and save money on energy bills in the future.

EPC assessments are valid for ten years for domestic properties and are available to view on the Landmark Register in England and Wales, and the Scottish EPC Register in Scotland.



▲ Figure 3.4 Loft insulation

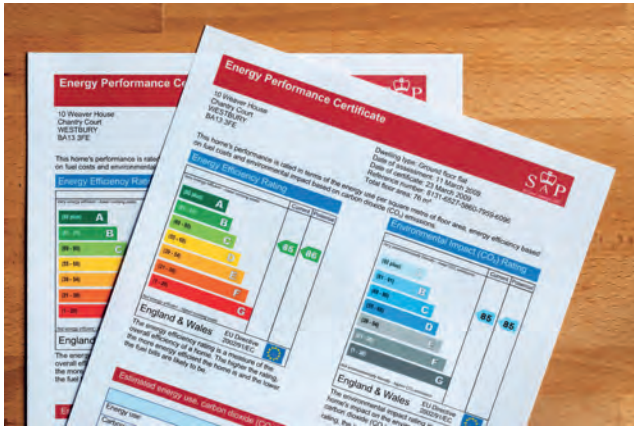

▲ Figure 3.5 Energy performance certificates

Case study

You decide to rent out your home. You do not have an EPC, so you appoint an EPC assessor to inspect your property.

- ▶ What energy efficiency rating do you think the assessor would award your property? Explain your answer.
- ▶ What recommendations do you think the assessor would make to improve the energy performance of your property and reduce your energy costs?

Code for Sustainable Homes

Launched in 2006, the Code for Sustainable Homes was a government-led environmental assessment method for rating and certifying the performance of new homes in the UK. It set national standards for the design and construction of new domestic properties, with the aim of improving sustainable building methods.

The government withdrew the code in 2015 and consolidated some of the benchmarks into existing building regulations. Although adherence to the code is no longer a condition for new planning proposals, it still endures where outline planning permission was granted before March 2015 or where there are existing contractual arrangements.

Site waste management plan (SWMPs)

A site waste management plan (SWMP) sets out how waste will be managed and disposed of during a construction project.

The plan should be prepared by the client, along with the design team, contractor and subcontractor, and it should identify:

- ▶ the different types of waste that will be created throughout the project
- ▶ where the waste is expected to be found
- ▶ the minimum estimated quantities of each type of waste
- ▶ the actions that the client and principal contractor intend to take to minimise the amount of waste by reusing and recycling.

For more information on waste management and SWMPs, see Chapter 5, section 8.



▲ Figure 3.6 Construction site waste being recycled in skips

Building regulations (Part L)

Part L of the building regulations is concerned with the conservation of fuel and power in new buildings (Approved Document L1A) and existing buildings (Approved Document L1B). (There is further information on Approved Documents in section 2.1 of this chapter.)

To help the government meet its targets to reduce carbon emissions, the regulations identify measurable rates to determine the energy efficiency of a building.

- ▶ The calculated rate of CO₂ emissions from a dwelling (the Dwelling CO₂ Emission Rate, DER) must not exceed the Target CO₂ Emission Rate (TER).
- ▶ The Dwelling Fabric Energy Efficiency (DFEE) rate must not exceed the Target Fabric Energy Efficiency (TFEE) rate.

The regulations also provide technical guidance on the quality of materials and standards of work to achieve the TER and TFEE rates in areas such as secondary heating and lighting.

Test yourself

What part of a building is the superstructure?

1.2 The benefits of good design and the potential implications of poor design

A building that has been properly thought out and planned will benefit the end user in many ways. Prospective buyers often look for the following qualities in new homes.

- ▶ Aesthetics – the building should have ‘kerb appeal’ (it should be attractive when viewed from the road) and have modern amenities. It should be in keeping with its surroundings and add value to the community.
- ▶ Efficiency – the building should have a good energy efficiency rating, allowing it to be cost-effective to run.
- ▶ Sustainability – the use of sustainable materials and alternative energy sources could make the property more desirable.
- ▶ Wellbeing and improved quality of life – these can be achieved by maximising natural light and ensuring efficient ventilation within the building, as well as enabling access to outdoor living spaces such as gardens, terraces or balconies.
- ▶ Affordable quality – ‘affordable’ is considered a median household income or lower, determined by the local or national government. Careful selection of building materials, methods and processes without unforeseen delays will bring in the construction project on budget.
- ▶ Improved local/community facilities – this could include accessible parks, woodland, play areas, community outdoor gyms, sports clubs, leisure facilities and shops.
- ▶ Improved infrastructure – this could include footpaths, roads, parking, bus routes and pedestrian bridges.



▲ Figure 3.7 Newly constructed domestic houses for sale

Impact on the local community

A building must meet the needs of both the client financing the project (the ‘project sponsor’) and the local community, now and for future generations. A development that serves the purpose of the client but is not well designed or managed throughout the construction phase can cause disruption to the local community with noise, light and air pollution, not to mention increased construction traffic and on-street parking.

A poorly planned development could have a negative impact on both the local economy and the way the area functions, for example, consider the effect it might have on local **infrastructure**. On average, most of the new occupants will drive some form of vehicle that will increase the amount of traffic in the area, particularly at peak times. This may result in delays, wear and tear on the roads, increased pollution and limited parking. The higher population will increase demand on local schools, healthcare facilities, shops and the job market.

Key term

Infrastructure: the basic systems and services that a country or organisation needs in order to function properly, including transportation systems (roads, footpaths, railways, bridges, tunnels and airports), water supplies, sewers and telecommunications systems



▲ Figure 3.8 Infrastructure of a community

Building new houses creates short-term employment opportunities for the development team. However, when the building phase is completed, those houses will be sold and occupied by people with social and economic needs.

To ease the shortage of **affordable housing**, it is often a condition of planning approval that a percentage of all newly built homes will be allocated to meet this need. The National Planning Policy Framework states that at least ten per cent of most new developments should be affordable housing.

Key term

Affordable housing: housing for sale or rent, for those whose needs are not met by the market (including housing that provides a subsidised route to home ownership and/or is for essential local workers); this means that low-income households can buy or rent properties at an affordable price, based on their earnings

Improve your maths

Research the average wages for five different trades in your area, then determine the annual median wage.

Impact on parties in the construction chain

A new housing development needs to enable a local community to function and grow, and to bring employment opportunities. A failure to meet these

needs will be reflected in slow sales and reduced profitability.

Large housing developments are usually divided into smaller phases by the building management team. Each phase is completed and sold in turn, to finance further phases of the overall development. If the development and buildings have not been well designed and constructed in the right area at the right time, then slow sales at an early stage in the development can have a major impact on a number of different parties in the construction chain:

- ▶ The client may be unable to finance further phases or to make repayments to the project sponsor (for example, a bank, a shareholder or an investor). Broken repayment agreements could result in financial penalties for the client. A failed venture could damage the client's reputation and impact on the financing of future developments.
- ▶ The project sponsor may not finance any further building work or future developments.
- ▶ Construction work might be paused, leading to a reduction in size of the project team until sales pick up and further phases of construction work are started. This could cause difficulties when building recommences in terms of re-employing contractors and subcontractors at the right time, leading to further delays.
- ▶ Suppliers may not be paid on time by contractors and subcontractors, because they are no longer employed. This can lead to a loss of confidence and goodwill, making it difficult to find suppliers willing to provide further building materials or credit terms. Material costs could increase the longer the development is delayed.

Impact of poor design and poor quality of work



Poor design and poor quality of work can result in a building failing to perform as expected after transfer of ownership to the end user. This can result in further negative impacts on the customer and client, such as high energy bills and the fabric of the building degrading.

Materials that have been inappropriately specified, selected, stored and used during construction work can often lead to failures at a later stage. Building materials can fail when exposed to certain conditions, as shown in Table 3.1.

▼ Table 3.1 Common failures in building materials

Building material	Failure	Cause
<p>Ferrous metal</p> 	Corrosion (an electrochemical process)	Exposure to moisture and other chemicals
<p>Timber</p> 	Decay/collapse (when the timber contains no chlorophyll)	Fungal attack (dry/wet rot) due to moisture content above 20 per cent Woodworm
	Warp, splits and shakes	Poor storage (unsupported/exposed to the elements/poor seasoning)
	Burning	Unprotected timber positioned too close to a heat source
<p>Brickwork and concrete</p>  	Deterioration and cracking of concrete or mortar joints Splitting of bricks and blocks	Frost attack as a result of water expanding as it freezes in porous materials Sulphate attack Incorrect ratios of materials used in the mixing of mortar and concrete
	Efflorescence	Water containing salt in the materials migrating to the surface and drying
<p>Paint</p> 	Flaking/peeling	Ultraviolet light (sunlight) attacking the paint Inadequate paint preparation and poor choice of primers



Building material	Failure	Cause
Plastic 	Becoming brittle	Ultraviolet light (sunlight) attacking the plastic
	Expansion and contraction	Extreme temperatures (heat/cold)
	Discolouration	Low-grade plastic
Glass 	Misting	Failure of seals between double-/triple-glazed units, causing the thermal gases to escape and moisture to enter between the layers of glass

Key terms

Ferrous metals: metals that contain iron and are vulnerable to rust when exposed to moisture

Sulphate attack: a chemical process where sulphates cause the cement in concrete to deteriorate, often resulting in cracking

Test yourself

What are the benefits of good design and the implications of poor design?

- ▶ resources (labour, plant and equipment)
- ▶ environmental impact
- ▶ scheduling
- ▶ appraisal of the proposed development site regarding existing services, waterways, boundaries and **topography**
- ▶ investigations into the history of the land above and below ground, identifying any unforeseen features that have the potential to make building work more complicated and costly, such as old wells, tunnels and mines
- ▶ historical architectural interest or any existing features, structures or buildings that could delay construction work or even prevent it from going ahead.

1.3 Factors that can impact on the profitability of projects

At the planning stage of any development, a **feasibility study** is usually carried out by the client and the management team, to check that the project is both viable and potentially profitable. The study usually considers areas such as:

- ▶ finances (profits/losses)
- ▶ budgets

Key terms

Feasibility study: an investigation to establish the likely success of a proposed project

Topography: the physical features and shape of land surfaces



▲ Figure 3.9 The topography of a piece of land

Greenfield and brownfield sites

Reusing a brownfield site for a new development makes environmental sense. However, from a financial point of view it is more costly, because existing buildings need to be removed and the ground needs to be prepared (for example, by clearing contaminated soil and waste).

For ease of building purposes and to maximise profits, many developers would prefer to use a greenfield site. Building work can usually start quickly on these sites with less preparation, and contractors do not have to contend with any existing hazardous waste or unforeseen development issues. However, building on a greenfield site is controversial, as many people believe we have a moral responsibility to protect the environment. There may also be local planning restrictions in place to preserve greenfield sites and only allow new developments when certain criteria are met.

Over-specification and difficulty of assembly

Developments that are over-specified or over-engineered can result in lower profits, even before construction work has begun. Unique design ideas and complicated assembly of components often result in difficulties during manufacturing and construction, due to the workforce's lack of familiarity, knowledge and skills. These complications can lead to increased timescales, missed deadlines and stretched budgets.

Vernacular construction

The design of the houses in a development may be sympathetic or particular to a region, relying on locally sourced materials and traditional skills that have developed over generations. This method of region-specific house building is referred to as vernacular

construction. Traditionally, construction methods did not follow contemporary mainstream architectural designs, until the Victorian period when building materials and styles became increasingly standardised.

Given the distinct regional characteristics of such buildings, it is problematic to design and specify this form of construction anywhere other than where it is usually found. It would be difficult to achieve the same standards of work without employing labour and sourcing materials from further away.



▲ Figure 3.10 This stone house in the Cotswolds, built with local materials, is an example of vernacular construction

Corporate social responsibility (CSR)

Although construction businesses need to make a profit, this should not be at the expense of the world around them. Corporate social responsibility (CSR) refers to strategies adopted by businesses to ensure they monitor and manage their social, economic and environmental impact on all aspects of society.

The CSR business model is self-regulated and can take many different forms, depending on the type of industry. It supports companies in being socially accountable to themselves, their stakeholders and the general public, in order to have a positive influence on the world. Businesses using this model not only benefit society but also themselves, by boosting morale between employers and employees and improving the reputation of their corporate brand.

Typical examples of CSR in construction include:

- ▶ providing services for the community
- ▶ supporting charitable activities
- ▶ using ethically and sustainably sourced building materials
- ▶ reducing the environmental impact of construction work.

Research

Search online for the International Organization for Standardization's guidance document 'Discovering ISO 26000'. You can access it here: www.iso.org/files/live/sites/isoorg/files/store/en/PUB100258.pdf

Research what social and ethical responsibilities could be adopted by your work-placement employer to manage their impact on society and the environment.

Test yourself

What factors could have an impact on the profitability of a building project?

2 Design principles

2.1 Factors to be considered during the design of building services

A client must consider many factors as part of their **concept** for a building, and some of these are more obvious than others, for example:

- ▶ building capacity
- ▶ number of bedrooms and bathrooms
- ▶ internal arrangement of rooms and other spaces
- ▶ parking and garages
- ▶ aesthetics (design features, choice of materials and use of colour).

Key term

Concept: a principle or idea

One of the most important factors to consider when planning a building project is the availability of mains services, such as electricity, water and drainage. If all these services are not easily accessible at the site (for example, in rural locations), then it could be expensive to connect to them. This usually involves paying service providers to dig long trenches in the ground to run pipes and cables to the boundary of the development, which is not always feasible and may cause damage to the natural environment. Special permission may also need to be obtained if this involves working on someone else's land.

Even if the proposed new development is on a brownfield site, there is no guarantee that the services provided will be in good order, for example, older water pipes may have low pressure or the water supply may be contaminated if the pipes are made of lead or corroded steel.

In remote locations where mains water cannot be accessed, a borehole may have to be drilled into the ground to find a natural water source. This can be very expensive, because the depth of the hole and the ground conditions are relatively unknown until the drilling starts, and any water that is found will have to be filtered and purified before use.

A client may choose to have a self-contained site using alternative energy sources, such as photovoltaic panels for electricity and lighting, ground- and air-source heat pumps to supply heating and hot water, and storage tanks for sewage. The main benefit of this approach is that it does not rely on the use of finite fossil fuels to generate power, and although the initial installation costs can be quite high, these will be offset with reduced energy bills over a period of time. For more information on energy sources, see Chapter 4.



▲ Figure 3.11 Services being connected

Approved Documents

In many ways, the design of a building and the choice of construction method are influenced by local authority planning restrictions and building regulations. The Ministry of Housing, Communities and Local Government publishes guidance on how to comply with building regulations in the form of Approved Documents. These provide general advice on the performance expected of materials and building work, and practical solutions to some of the more common building situations.

Approved Documents are divided into the key areas listed below:

- ▶ Structure: Approved Document A
- ▶ Fire safety: Approved Document B
- ▶ Site preparation and resistance to contaminants and moisture: Approved Document C
- ▶ Toxic substances: Approved Document D
- ▶ Resistance to sound: Approved Document E
- ▶ Ventilation: Approved Document F
- ▶ Sanitation, hot water safety and water efficiency: Approved Document G
- ▶ Drainage and waste disposal: Approved Document H
- ▶ Combustion appliances and fuel storage systems: Approved Document J
- ▶ Protection from falling, collision and impact: Approved Document K
- ▶ Conservation of fuel and power: Approved Document L
- ▶ Access to and use of buildings: Approved Document M
- ▶ Electrical safety: Approved Document P
- ▶ Security in dwellings: Approved Document Q
- ▶ High-speed electronic communications networks: Approved Document R
- ▶ Materials and workmanship: Approved Document 7.

Listed and heritage building regulations

Existing buildings may be protected by listed and heritage building regulations. If a building has special architectural or historical interest, not only will the structure of the building be protected, but also any other attached structures or features, including interiors.

Listed buildings are graded according to their national importance:

- ▶ Grade I (one) – buildings of exceptional interest
- ▶ Grade II* (two star) – particularly important buildings of more than special interest
- ▶ Grade II (two) – buildings of special interest warranting every effort to preserve them.

If a client wants to alter, extend or change the use of a listed building, they must apply to the local authority for 'listed building consent' and be granted permission before any work begins. The grade of listing usually determines what changes can be made and how they should be implemented, although any work will have to be carried out sensitively in order to protect the character and history of the building or structure.



▲ Figure 3.12 A listed building

Traditional versus modern building methods

It is important during the planning stage of any building project to consider carefully which construction method will be most appropriate.

Traditional methods of constructing walls, floors and roofs for **low-rise buildings** have evolved in recent years, in order to meet regulations and building standards on energy efficiency and sustainability. However, this type of construction can be labour-intensive and usually results in longer build times, because the entire superstructure is completed on site with low levels of **mechanisation**. During the initial stages of the construction work, before the building is watertight, the progress made is often weather dependent, for example, bricklayers cannot lay bricks at temperatures below 2°C or during periods of heavy rain. Traditional construction methods also tend to produce a lot of waste.



Key terms

Low-rise buildings: buildings with four storeys or fewer



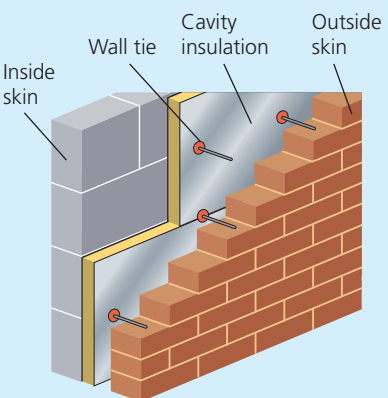

Mechanisation: the use of machines or automatic devices

Table 3.2 compares some of the most common traditional and modern construction methods.

▼ Table 3.2 Comparison of traditional and modern construction methods

Method of construction	Traditional/ modern	Advantages	Disadvantages
<p>Brick and block</p> 	Traditional	<ul style="list-style-type: none"> • Familiar • Good thermal performance • Good sound insulation • Can be used with concrete upper floors • Good structural performance • Durable • Good fire resistance • Good weather exclusion 	<ul style="list-style-type: none"> • Thick walls due to insulation between inside and outside skin • Takes time to dry out • Cannot be carried out in heavy rain or freezing conditions • Production of cement creates high levels of carbon, which is harmful for the environment
<p>Open panel – timber frame</p> 	Traditional	<ul style="list-style-type: none"> • Sustainable building material if the timber is from a managed forest • Factory-built framework reduces on-site build times • Good thermal performance and sound insulation (although this is reliant on the infill panels between the open frames) 	<ul style="list-style-type: none"> • Can be more expensive than other building methods • Water can stain the exposed timber in the early stages of construction
<p>Straw-bale construction (non-structural/infill system)</p> 	Traditional	<ul style="list-style-type: none"> • Sustainable • Low cost • Quick to build • Good thermal performance • Good sound insulation • No drying out required 	<ul style="list-style-type: none"> • At risk of damage from vermin • Increased risk of fire • Uneven wall-surface finishes • Straw rots easily if exposed to moisture
<p>Panelised – timber frame</p> 	Modern	<ul style="list-style-type: none"> • Manufactured off site in a factory, thereby reducing on-site build times, labour requirements/costs and health and safety risks (for example, working at height) • Quick to erect the shell of the building to make it watertight • Sustainable building material • Good thermal performance • Reduced waste (factory manufactured) • Accurate, easy to adjust and fix to • Thinner walls compared with other methods 	<ul style="list-style-type: none"> • Unable to support concrete upper floors • Long lead time for panels to be made off site • Liable to rot if exposed to moisture

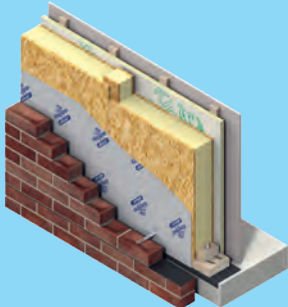

Method of construction	Traditional/modern	Advantages	Disadvantages
Insulated concrete formwork (ICF) 	Modern	<ul style="list-style-type: none"> • Excellent thermal performance • Good sound insulation • Good weather exclusion • Durable • Excellent structural performance • Good fire resistance 	<ul style="list-style-type: none"> • Inexperienced workers may need training to use the system • Poor preparation of the formwork (concrete mould) can lead to difficult and expensive repairs once the concrete has been poured and cured
Steel-frame construction 	Traditional	<ul style="list-style-type: none"> • Quick to erect • Excellent weather resistance • Durable • Excellent structural performance • Could support concrete upper floors • Good fire resistance 	<ul style="list-style-type: none"> • Expensive • Heavy • Requires a crane to lift the steel frame into position • Can distort if exposed to extreme heat (for example, in a fire)
Thin-joint blockwork/masonry 	Modern	<ul style="list-style-type: none"> • No drying out of mortar joints needed • Quick to build • Excellent weather exclusion • Durable • Excellent structural performance • Fire resistant • Excellent thermal performance • Good sound insulation 	<ul style="list-style-type: none"> • Slightly more expensive compared to traditional bricks and blocks • Accurate foundations needed to build on, because it is difficult to correct blockwork courses at a later stage as the walls are built
Structural insulated panels (SIPs) 	Modern	<ul style="list-style-type: none"> • Good thermal performance • Manufactured off site in a factory, thereby reducing on-site build times, labour requirements/costs and health and safety risks (for example, working at height) 	<ul style="list-style-type: none"> • Precise foundations required to align the SIPs; any deviation could result in costly delays • Requires a crane to lift the panels into position
Volumetric (pod/modular) 	Modern	<ul style="list-style-type: none"> • Manufactured off site in a factory, therefore reducing on-site build times, labour requirements/costs and health and safety risks • Better quality control and accuracy maintained in a factory because of the level of automation used 	<ul style="list-style-type: none"> • Initially more expensive • Requires a crane to move the pods into position, which can be expensive to acquire if not already on site

Key terms

Skin: a single thick masonry wall

Watertight: when a building is at the stage of construction where the weather cannot penetrate it (for example, the roof is on and the windows and doors are fitted)

Lead time: the period of time between ordering and receiving goods or materials

Test yourself

What are the advantages of modern construction methods compared with traditional methods?

Buildability

Some modern construction methods involve parts or sections of a building being manufactured away from the site location. Large sections of walls and floors (referred to as cassettes), roof trusses and even whole rooms (known as pods) can be prefabricated more quickly in factories, with better quality control. Production is not delayed due to adverse weather conditions, and off-site factory manufacturing also reduces on-site build times, labour requirements/costs and some health and safety risks.

This method of combining factory-produced, pre-engineered units (or modules) to form major elements of a structure is referred to as modular construction. It results in improved 'buildability'; because potential assembly issues are usually designed out at an early stage for ease of construction on site. However, the feasibility of using heavy lifting equipment and cranes on site to lift the large building sections into place, alongside the increased risks to the safety of workers and others, have to be factored into the planning of a project.



▲ Figure 3.13 A cassette being lifted into position on site

Key term

Buildability: the simplicity of manufacturing or constructing a building through its design

Choosing a method of construction

It can be difficult deciding whether to construct using traditional or modern building methods and materials.

Traditional construction generally uses less-sustainable technologies and materials that produce high levels of CO₂ during manufacture. However, the costs of maintaining modern methods are normally higher over the lifetime of the building. For more information on sustainable methods of construction, see Chapter 7.

Whichever method is chosen, it has to meet the minimum standards determined by building regulations. However, some buildings will naturally perform better than others with regards to heat retention and **acoustics**. The ability of a building to maintain an ambient temperature for its occupants will not only be influenced by the **U-value** of the walls, floors and roof, but also by the construction of doors, windows and roof lights.

Key terms

Acoustics: the transmission of sound

U-value: a unit of measurement used to record thermal transmittance through a building material

Large windows, roof lanterns and bi-folding or sliding doors are popular features of modern homes. These allow natural daylight to illuminate large areas of the building, providing a feeling of more space and a connection between indoor and outdoor living.

The direction that a building faces on a plot and the carefully planned positioning of glazing will allow sunlight to warm a building through solar gain (the sun). This heat can also be stored in the fabric of the building during the day and released during the evening, which will reduce reliance on other sources of energy, decrease bills and maintain a comfortable living environment.

Windows and doors are not only important design features for access and egress (including for those with disabilities), but they are also a means of escape in the event of a fire. In order to maintain the health and wellbeing of the occupants of a building, openings in windows and doors allow for ventilation, whereby stale air is removed from the building and replaced with natural fresh air.



▲ Figure 3.14 Natural light entering a building through roof lanterns

Research

Search online for the ‘Building Research Establishment Environmental Assessment Method’ (BREEAM) and explain the role it plays in the design of the built environment.

Test yourself

What factors need to be considered during the design of building services?

Improve your English

‘Luminaire’ is a word used to describe a source of artificial light. Write a paragraph to explain the use of different types of luminaire in a building, and explain why natural light is always a better source of energy.

Test yourself

The installation and use of windows and doors are controlled by building regulations. Which Approved Documents provide information and guidance on this?

2.2 Stages and outcomes of the Royal Institute of British Architects (RIBA) Plan of Work

The RIBA Plan of Work is a design and process management tool used by the UK building industry to bring greater clarity for the client at different stages of a project.

It organises the process of briefing, designing, constructing and operating building projects into eight stages. Each stage has intended outcomes, core tasks and information that should be exchanged with different parties.

In recent years, the Plan of Work has been updated to reflect changes in the industry and to support the government’s target to be net zero carbon by 2050.

▼ Table 3.3 RIBA Plan of Work Stages and Stage Outcomes

	Stage	Outcome
Pre-design	0 Strategic definition	Determine the best way of achieving the client’s requirements and the most appropriate solution.
	1 Preparation and briefing	Develop the client’s concept and make sure it can be accommodated on site. Make sure everything needed for the next stage is in place.
Design	2 Concept design	Make sure the look and feel of the building is meeting the client’s expectations and budget.
	3 Spatial coordination	Design the spaces within the structure of the building, before preparing detailed information about manufacturing and construction.
	4 Technical design	Develop information received from the design team and specialist subcontractors for the manufacture and construction of the building.
Construction	5 Manufacturing and construction	Manufacture and construct the building.
Handover	6 Handover	Complete the building works and address any defects that have been identified, to conclude the building contract between the client and the contractor.
In use	7 Use	The building should be used, operated and maintained efficiently until the end of its life. At this stage, the client may consider appointing professionals for aftercare activities such as servicing and maintenance.

Source: RIBA Plan of Work 2020 Stages and Stage Outcomes reproduced courtesy of the Royal Institute of British Architects

Improve your English

The term 'spatial' is used in the RIBA Plan of Work to describe a space, position, area or size of things within a building. Write a sentence that includes the word 'spatial' to describe the arrangement of rooms on a level in a dwelling.

3 The role of different disciplines involved in design

3.1 Key job roles within construction design

There are many diverse disciplines that contribute to the design and execution of a building project. Each member of the project team is appointed by the client to provide specialist knowledge, skills and services.

The size of the development often determines how many people are involved, and many of them may have never worked together before. Complex information is communicated throughout the building and design team at various stages in the construction project, therefore it is important that roles and responsibilities are defined clearly at an early stage and recorded in the appointment documentation.

It is likely that some members of the project team will play only a brief role, and that the structure of the team will change throughout the development. In order to work effectively as a team and in the best interests of the client, communication needs to be clear and efficient, so that everyone is aware of what actions they need to take.

Let's look at some of the personnel who could be involved in the design and construction of a development.

Contractors

Contractors may be given responsibility by the client to design, plan, organise and control a construction project; this is commonly referred to as 'design and build'. Under the Construction (Design and Management) Regulations 2015, a **principal contractor** must be appointed when there is more than one contractor working on a project. The principal contractor then either appoints designers, or uses one of their own in-house designers, to manage this process as part of their project team.

The main benefit of this approach is that the client has fewer points of contact to communicate with at each phase of the development.

Many contractors start out as tradespeople to gain experience of the construction industry, before they progress into supervisory or principal contractor roles to manage building projects for clients.

Key term

Principal contractor: a contractor with control over the construction phase of a project involving more than one contractor; they plan, manage, monitor and coordinate health and safety during this phase

Operatives

Operatives support different tradespeople at every stage of a building project by completing manual labour tasks, such as stacking and storing materials, mixing mortar and tidying the site. The availability of skilled labourers for a construction project and their experience of working with a particular building method may influence the design.

Skilled general operatives may progress into a trade, and with further experience into supervisory roles such as trade foreperson (there is further information on this role in Chapter 4).

Architects

Architects are normally appointed by the client to design new buildings or structures, or to conserve or redevelop old ones. Part of their role is to work closely with clients, the local authority and main contractors to prepare:

- ▶ detailed drawings
- ▶ specifications
- ▶ feasibility studies
- ▶ a project brief
- ▶ planning applications
- ▶ **tender documents.**

Key term

Tender documents: documents prepared to seek offers for the supply of goods or services; once returned to the client, they will make a decision on the most suitable contractor for a project

Architects may also be contracted to:

- ▶ prepare other documents, for example, a site waste management plan
- ▶ undertake site inspections
- ▶ offer advice to the client at various stages of the building work to resolve any technical difficulties.

Knowledgeable architects who work within a larger company may progress to a senior position as a lead architect or choose to work for themselves as a freelance consultant.

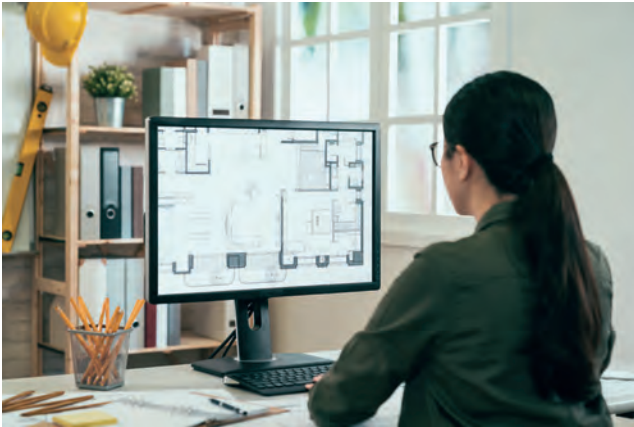

▲ Figure 3.15 An architect using computer-aided design (CAD)

Planners

The role of planners is to ensure that land in villages, towns, cities, the countryside and commercial sites is used effectively to meet economic, social and environmental needs. Their objective is to achieve a balance between encouraging innovation and growth in the development of housing, industry, agriculture, recreation and transport while trying to preserve the historical environment.

Planners can also work as consultants for clients and provide advice on local planning policy to architects and developers. They can consult with stakeholders to determine planning applications, contest appeals and enforce planning legislation.

Experienced planners may leave the local planning department to become independent, advising contractors and clients on planning and design to meet the local authority's requirements with regards to planning applications.

Building control officers/private building inspectors

Building control officers (BCOs) work for Local Authority Building Control (LABC). Private building

inspectors work for government-approved building-inspection companies. Private building inspectors do not have the same powers of enforcement as BCOs, which means that their role may have to be transferred to LABC if there is a problem that cannot be resolved without its intervention.

The role of the BCO is to inspect plans submitted for full planning approval, making sure they meet current building regulations. At intervals agreed between the BCO and the contractor, they will visit the construction site and check that it meets with regulatory standards of design and safety.

The progression route for a BCO might involve becoming a member of the local authority planning committee.



▲ Figure 3.16 A building control officer (BCO) on a construction site

Industry tip

Never deviate from approved working drawings during the construction phase without written consent from either Local Authority Building Control or a government-approved private building inspector. Changes to the design without permission can be expensive to put right if the work fails to meet building regulations approval.

Manufacturers

Manufacturers are responsible for the design, production and sale of building materials and goods. Before their products are sold and distributed to the end user, they are tested and certified to ensure they adhere to industry standards and regulations (for example, the Ecodesign for Energy-Related Products Regulations 2010).

Designers may choose certain materials based on their sustainability, eco-design and energy rating, which means that manufacturers can influence the design and use of buildings through their products.

Mechanical building services (design) engineers

Mechanical building services (design) engineers consult and advise clients on the design, installation, operation and maintenance of building services such as:

- ▶ heating systems
- ▶ ventilation systems
- ▶ air-conditioning systems
- ▶ renewable-energy systems
- ▶ sustainable technologies.

Their technical knowledge of building services may also be utilised by the client for the production of detailed drawings, specifications and calculations to meet with design standards and regulatory requirements. They may be involved in bids and tenders for work, and mentor the client from the start to the completion of a project.

Electrical building services (design) engineers

Electrical building services (design) engineers consult and advise clients on the design, installation, operation and maintenance of electrical systems for domestic, commercial and industrial projects, such as:

- ▶ lighting systems
- ▶ fire-safety systems
- ▶ security systems
- ▶ renewable-energy systems, for example, solar photovoltaic (PV) panels and electric-car charging points.

Mechanical design engineers (building services)

Mechanical design engineers use their specialist knowledge of complex mechanical systems to design, manage and supervise projects for the client, from concept to completion.

They often work closely with electrical engineers to ensure the design and installation work is carried out safely and in accordance with industry codes of practice.

Mechanical engineer design coordinators

Mechanical engineer design coordinators are usually appointed to assist the mechanical design engineers

on larger projects, using their technical expertise to create innovative solutions to building-services problems. They may also organise tendering, project management, reporting and scheduling for the client when required.

Mechanical engineer CAD technicians

CAD technicians produce technical information and 2D/3D mechanical diagrams using computer-aided design (CAD). They create manufacturing drawings and work instructions for the building services team. This information is then used to improve the buildability of the project and reduce construction costs for the client.

BIM designers

BIM designers work with clients to implement 'Building Information Modelling' (BIM). BIM is an intelligent, streamlined process of sharing digital information (for example, 3D models, drawings, specifications and schedules) between all parties and stakeholders. This cost-effective process allows a collaborative approach at every stage of planning, designing, building and managing a project, to improve efficiency and productivity throughout the life cycle of the building.

Retrofit assessors

Retrofit assessors undertake assessments of existing buildings in order to compile energy efficiency improvement plans for clients. They may also visit sites to:

- ▶ resolve issues (for example, maximising the use of PV panels on a building with a complex roof shape)
- ▶ review projects
- ▶ carry out audits to ensure health and safety and performance standards are being met.

Retrofit coordinators

Retrofit coordinators liaise with retrofit assessors, retrofit installers and clients about the installation of renewable-energy technologies in existing buildings, for example, solar thermal, biomass and air-/ground-source heat pumps.

An important part of their role is to gather data from the retrofit assessors, then to check its accuracy and produce an improvement plan for the client. The client may also make arrangements for a coordinator to appoint an approved installer to carry out the work identified in the plan.

Retrofit installers

Retrofit installers (also known as retrofit installer technicians) are responsible for the installation, commissioning and final handover to the client of renewable energy systems and measures. Installers must be PAS 2030:2019 certified and meet these standards on all retrofit projects.

Competent and experienced retrofit installers may progress in their careers to become retrofit assessors.

Research

Search online for 'PAS 2030:2019 Specification for the installation of energy efficiency measures in existing dwellings and insulation in residential park homes'.

Identify the standards of PAS 2030:2019 for retrofit installers and explain how they benefit the construction industry.



▲ Figure 3.17 Retrofit installer fitting an energy-efficient boiler

4 Design process from conception to completion

4.1 Key stages of the design process, and factors that may impact or influence design changes

House building can be a relatively straightforward process when good design principles are applied, the project has been well planned and there are no unforeseen problems encountered during the construction phase. However, when you are dealing

with the natural environment no two sites are ever the same. It is therefore fundamental that the land is properly investigated to identify any potential issues early and reduce the risk of additional costs later in the build.

Individuals or organisations responsible for preparing or modifying designs for construction projects have legal duties under the Construction (Design and Management) Regulations 2015.

Designers must:

- ▶ ensure the client is aware of their duties under the CDM Regulations and help them to comply with those duties
- ▶ take into account any preconstruction information provided by the client
- ▶ eliminate foreseeable health and safety risks where possible
- ▶ seek to reduce or control any health and safety risk that cannot be eliminated
- ▶ provide design information for inclusion in the health and safety file for the project
- ▶ coordinate with other designers working on the project on matters of health and safety during the construction phase and beyond
- ▶ coordinate, communicate and cooperate with all contractors working on the project, taking into account their knowledge and experience of building design.

Further information on the CDM Regulations can be found in Chapter 1.

In this section, we will look at the importance of researching and analysing building plots, as well as the process of applying for planning permission, through to the final sign-off of the building work.

Test yourself

What legal duties do designers have under the Construction (Design and Management) Regulations 2015?

Research

Before construction work begins, a **desktop survey** is usually undertaken to identify and record details about previous and current uses of the site. The main objective of this survey is to support the design and construction processes, by allowing correct decisions to be made when planning the site layout.

A desktop survey will look to establish the following information:

- ▶ site history
- ▶ waste records
- ▶ geology and **hydrology**
- ▶ contamination reports
- ▶ site boundaries
- ▶ position of existing services
- ▶ existing structures or buildings
- ▶ local roads
- ▶ access to the site
- ▶ topography of the land
- ▶ hedges, trees and fences
- ▶ wildlife and habitats.

Much of this information can be gathered from existing plans and records held by the Environment Agency and the Land Registry.

If a specialist or consultant is appointed, they will also produce an **environmental risk assessment**. This document is used to identify potential risks to the natural environment from the proposed building work.

A site of special scientific interest (SSSI) may be identified in the initial survey. This is an area that must be protected from construction activities due to its rare **flora** or **fauna**, or its physiographical or geological features.



▲ Figure 3.18 Flora



▲ Figure 3.19 Fauna

Key terms

Desktop survey: an investigation into a piece of land completed without visiting the site or taking physical samples of soil etc.

Hydrology: the study of water in the earth and its relationship with the environment

Environmental risk assessment: a document used to identify and control potential risks to the natural environment from construction work

Flora: plants and trees in a particular region

Fauna: animals in a particular region

Case study

A feasibility study for the construction of 75 new homes has identified the existence of fauna on the proposed building site.

Explain in detail what animals are protected and the potential outcomes now that these indigenous species have been discovered on the land.

Site analysis

Once the desktop survey has been completed, a **walkover survey** is usually undertaken. This is a physical inspection of the building site to identify any geological, ecological or topographical issues that may impact the project.

It involves drilling boreholes into the ground at various positions on the site to investigate the:

- ▶ composition of the soil
- ▶ load-bearing capacity of the ground
- ▶ position of the water table.

The water table is the point below the ground where the soil becomes saturated; this depth will vary depending on the location of the site.

The information gathered from the walkover survey is interpreted and used to determine the most appropriate form of foundation to suit the ground conditions.

Key term

Walkover survey: a physical inspection of a building site



▲ Figure 3.20 The water table

Research

Search online for the various methods of soil investigation and explain why they are used.

Planning

Under permitted development rights, you can extend or make certain alterations to an existing domestic property without the need for planning permission from the local authority. However, if the proposed changes are outside of the specific limitations of the rules, or new dwellings are to be constructed, then planning permission must be sought and granted.

Industry tip

Regardless of whether or not planning permission is needed, all building work must be completed in accordance with current building regulations.

The process of making an application for planning approval through to the final decision made by the planning committee can be lengthy and expensive, especially when you consider the investment in time, effort and money in designing the project.

To improve the efficiency of the application process and reduce any potential financial losses, a pre-planning application should be made to the local planning department. This type of application is usually processed much more quickly than a full application, where detailed drawings and specifications are often needed. Local planning departments encourage pre-applications so that they can offer support and guidance to resolve any issues in the proposal, therefore providing a realistic chance of the final application being successful.

If planning permission is required for a project, an application must be made to the local authority by the client or planning team, accompanied by a fee and supporting documentation. The design plans for the site will identify the boundary, **frontage line** and **building line**. These may be stipulated by the local planning department as a condition of planning approval.

At this stage, details of the planning application are advertised by the planning department in local newspapers and on the site of the proposal. Consultation letters are sent to neighbours, informing them about the application and advising how they can view the plans online or raise any valid objections to the project going ahead within a period of 21 days from the date of publishing.

Research

Find out what documents and types of drawing are needed to make a full planning application to a local planning department. Suggest the possible outcome if some of this detail is not provided.

Key terms

Frontage line: the front part of a building that faces a road

Building line: a boundary line set by the local authority beyond which building work must not project



▲ Figure 3.21 A planning application notice

During the consultation period, a planning officer from the local planning department will visit the site, where they will take into account information provided in the application and any responses from the public or their representatives. They may also gather further site-specific information, such as measurements and photographs, in order to make their ‘officer’s report’. The planning officer is not responsible for making a planning decision at this stage, but will make recommendations for the authorised person or planning committee to base their final decision on.

The final outcome for the majority of domestic planning applications is usually decided by senior officers, under delegated powers from the planning committee.

There are three possible outcomes for a planning application:

- ▶ approved
- ▶ approved with conditions that must be complied with (for example, ‘No further windows can be added to the proposal on the east elevation of the property’)
- ▶ refused.

Applications that have been refused can be appealed, however this can be a lengthy and expensive process that is not always successful.

Construction work can be carried out on domestic buildings by submitting a ‘building notice’ to the local planning department, without the need to submit a full planning application. Although work can start immediately once a building notice has been submitted, lack of detail in the notice could result in

the work not complying with building regulations and therefore having to be dismantled or corrected after it has been completed. It is therefore recommended that a building notice is used only for minor building works, or if the contractor has good knowledge of current building regulations.

TORBAY COUNCIL				Building Regulations			
				Building Notice Application			
* Applicant's Details (see notes 1 and 3)				Agent's Details (if applicable)			
Title: Mr/Mrs/Miss/Ms Other.....				Send invoice to applicant/agent (delete as appropriate)			
Surname:							
Forename:							
Address:				Address:			
* Postcode	Tel H	Postcode	Tel H				
	Tel M		Tel M				
	Tel W		Tel W				
Email				Email			
Is the work being done through an agent? YES / NO				Planning Application Reference Number (If Applicable).....			
If so, please fill in Agent's details above.							
Location of building to which work relates							
Name of Builder:				Builder's Tel (W)		Builder's Tel (M)	
Proposed work (see exclusions overleaf)							
Description:							
Use of building							
1 If new building or extension please state proposed use:							
2 If existing building state present use:							
Fees (see note 3 and separate Guidance Note on Fees for information)							
1 If Table A work please state number of dwellings							
2 If Table B work please state floor area: _____ m ²							
IN ALL CASES please state 100% of estimated cost of work excluding VAT: £ _____							
Gross Plan fee: £ _____							
Means of water supply (see note 3.3)				Means of drainage			
				1: Foul Drainage			
				2: Surface Water			
* Statement							
This notice is given in relation to the building work as described, is submitted in accordance with Regulation 12(2)(a) and is accompanied by the appropriate fee.							
Name:.....				Signature:.....		Date:.....	
BUILDING NOTICE CHECK LIST							
Completed and signed this Form? / No need to sign if electronic.							
Enclosed the block plan mentioned in point 3 overleaf.							
Building within 3m of sewer or public lateral drain (see note 3.2)?							
Fee – Card payment link will be forwarded once processed.							
Or. Card payment can be processed over the telephone.							
				FOR OFFICIAL USE ONLY			
				Purpose Group:			
				EST COST:			
				B.N. FEE: £			
				FEE PAID: £			
				Fee Checked by:			

▲ Figure 3.22 A building notice application

Research

Search online to find out how to submit a building notice to your local planning department. Download and complete (without submitting it!) a building notice application for a fictitious extension to your home.

Approval/review

Once building work has commenced on site, it must be inspected at regular intervals by either a building control officer (BCO) from Local Authority Building Control (LABC) or a private building inspector.

The quality and standards of work are checked against building regulations at the following stages:

- ▶ excavation of the foundation
- ▶ laying of foundation concrete
- ▶ installation of damp-proof course (DPC) and damp-proof membranes (DPM)
- ▶ laying of drains
- ▶ completion of the roof structure
- ▶ completion of first-fix installations (before plastering or dry lining)
- ▶ testing of drains
- ▶ completion of the project.

Where the standard of work falls below that expected, recommendations are made by the inspector to meet legislation.

Building regulations state that any person intending to carry out building work must notify LABC to determine stages of work and when they will be inspected. This is known as an 'inspection service plan'.

Project sign-off

As soon as possible after a building project has finished, the contractor or client must notify LABC, so that it can arrange a final visit to the site. During the inspection, the BCO will check that any outstanding actions from previous visits have been completed and verify that the dwelling meets with building regulations. Once satisfied with the building work, they will issue a completion certificate. Until this certificate is issued, a building is not '**signed-off**' and therefore should not be occupied, and it may be difficult to insure it or secure a mortgage.

Key term

Signed-off: approved by a building control officer

4.2 Project planning

Part of successful planning for a construction project involves scheduling resources, materials and labour for various times throughout the building phase. If this is not given careful consideration at the planning stage, it could result in delays on site, missed completion deadlines and financial penalties for the contractor.

It is inevitable that certain events during construction work will impact on progress, for example, poor weather, equipment failure or accidents. However, these can be factored into a **programme of work** as and when they happen, so that adjustments can be made to reduce the impact further down the line.



▲ Figure 3.23 A site manager monitoring progress against the programme of work

Key term

Programme of work: a document used by construction managers to plan and organise resources for a building project

Construction scheduling software is often used to prepare programmes of work as part of BIM, because it produces documents that are clear, simple to amend and easy to share with all project stakeholders.

The most commonly used programmes of work are:

- ▶ Gantt charts
- ▶ critical path analysis (CPA).

Gantt charts

Gantt charts are a type of bar chart. They are used to record the project start and completion times, and the sequence in which construction activities are scheduled to take place in between. Different coloured references are used to:

- ▶ highlight planned activity durations
- ▶ plot the current status of the project
- ▶ flag any amendments that need to be made to complete the project on time and within budget.

Task	Start date	End date	Planned duration (days)	March				April				May				June			
				1	8	15	22	29	5	12	19	26	3	10	17	24	31	7	14
1 Layout and preparation	02/03	06/03	5	█															
2 Excavation	09/03	17/03	9	█	█	█													
3 Reinforcement and formwork	16/03	27/03	12		█	█	█												
4 Foundation construction	23/03	27/03	5			█	█												
5 Structural steel	30/03	18/04	20					█	█	█	█								
6 Masonry	14/04	01/05	18						█	█	█	█	█						
7 Plumbing	21/04	25/04	5							█	█	█							
8 Electrical	21/04	23/04	3								█	█							
9 HVAC	21/04	25/04	5								█	█	█						
10 Roofing	28/04	08/05	11									█	█	█	█				
11 Plastering	08/05	12/05	5										█	█	█				
12 Carpentry	11/05	22/05	12											█	█	█	█		
13 Installation of windows and doors	18/05	22/05	5												█	█	█		
14 Terrazzo	18/05	29/05	12													█	█	█	
15 Glazing	01/06	12/06	12															█	█
16 Hardware	15/06	19/06	5																█
17 Painting	15/06	23/06	9																█
18 Exterior concrete	15/06	25/06	11																█

Key:
 Red = planned activity durations
 Blue = current status of the project
 Green = amendments that need to be made to complete the project on time and within budget

▲ Figure 3.24 A Gantt chart

Critical path analysis (CPA)

Critical path analysis (CPA) is a decision-making tool used to plan complex building projects. The order and expected duration of activities are plotted using a networking diagram, connected by a series of **node points** containing critical information.

CPA is used by the project management team to identify when each activity can start and opportunities to relocate resources to improve efficiency; these are referred to as 'float times'.

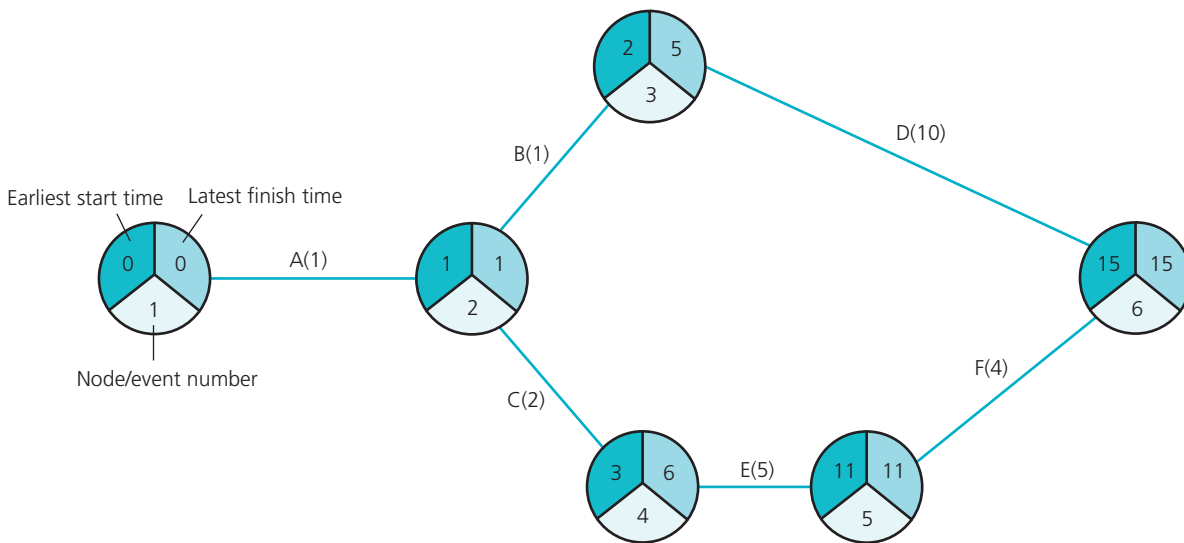

▲ Figure 3.25 Critical path analysis (CPA)

Key term

Node point: an intersection of lines or pathways in a diagram

Improve your maths

Search on YouTube for a tutorial on how to create a critical path analysis (CPA). Work with one of your peers to design a programme of work on a computer for a simple construction activity.

5 The concept of the 'whole building', including life cycle assessment

5.1 Life cycle assessment

Throughout this chapter, we have looked at how design and construction are influenced by different factors, such as legislation, and at the impact building works might have on the natural environment if measures are not taken to protect it. In order to design and construct 'green buildings', we need to consider the 'whole building' and understand how different construction systems work together and how this can determine project planning.

The term 'sustainable home' is sometimes broadly used when designing or planning; however, not all construction materials perform equally with regards to their carbon footprint. There is increasing demand among stakeholders for more sustainable and energy-efficient buildings, in order to reduce the effects on climate change. It is therefore important to understand the life cycle of construction materials, from their creation to their final use/disposal.

The impact that construction materials have on the environment can be calculated using a science-based tool known as 'life cycle assessment' (LCA). LCA accurately evaluates the effect that materials have at each stage of their life cycle, using data from Building Information Modelling (BIM) and other sources of information, and produces a report.

Key terms

Green buildings: buildings that have a low impact on the environment, during both their construction and use

Whole building: the impact of a building in terms of resources and effect on the natural environment, from the initial sourcing of raw building materials to manufacturing and construction etc.

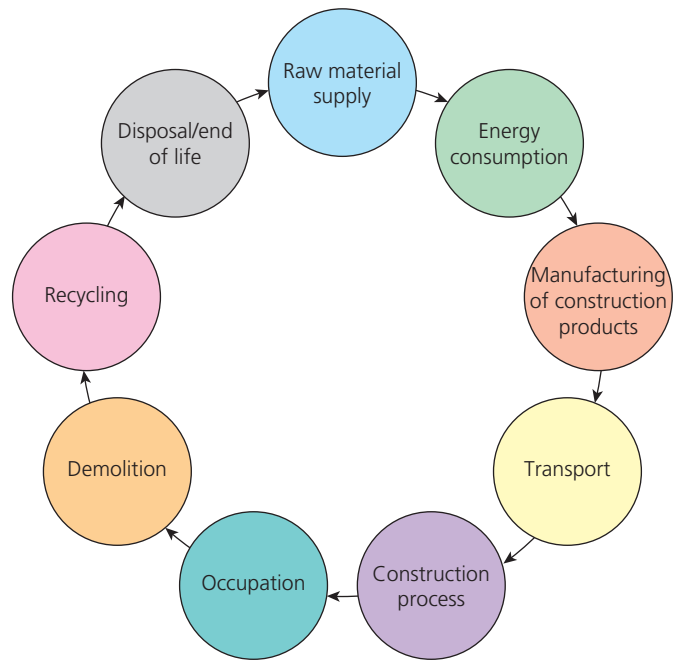

▲ Figure 3.26 Life cycle of building materials

LCA is a reliable source of data, controlled by international standards. Its findings identify areas in the building design that have the biggest impact on the environment. These areas can then be targeted by designers to alter the design or the materials used, to reduce the environmental impact.

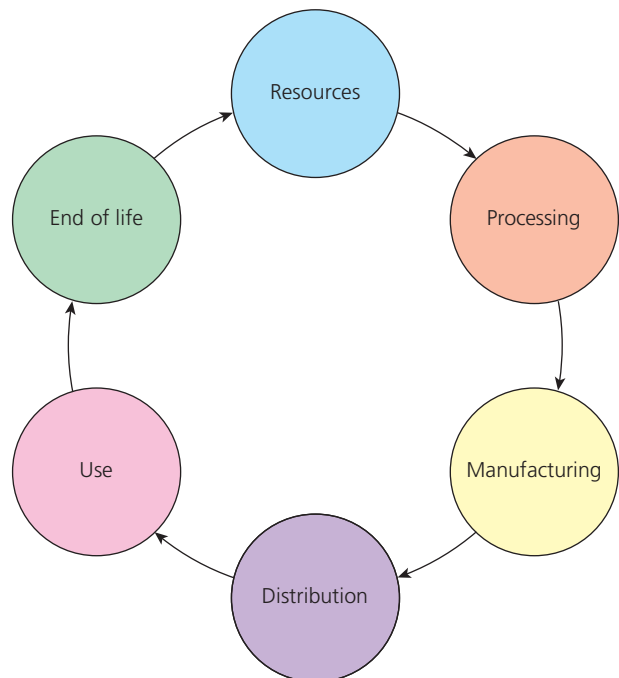

▲ Figure 3.27 Life cycle assessment (LCA)

Assessment practice

Short answer

- 1 Which Approved Document influences the design of a building's energy sources?
- 2 Under what rights are contractors and individuals allowed to carry out certain construction projects without planning permission?
- 3 Identify three stages of building work that are usually inspected by a building control officer.
- 4 What is the name of the design and process management tool used to bring greater clarity for the client at different stages of a building project?
- 5 Name one modern building method where components are constructed off site.

Long answer

- 6 Explain the difference between brownfield and greenfield sites.
- 7 Explain what is meant by vernacular construction and why it can impact on the profitability of projects.
- 8 Explain the role of a BIM designer.
- 9 What factors could influence changes to a building design?
- 10 List the steps for obtaining planning permission from the local planning department.

Project practice

A principal contractor has been appointed by a client for a 'design and build' project. A rural greenfield site has already been acquired by the client, but it does not have planning permission.

An application has been made to the local planning department, with plans for six new 3- and 4-bedroom low-rise dwellings. However, the plans have been initially refused by Local Authority Building Control.

Discuss in a group the potential grounds for LABC to oppose the planning application.

Bearing in mind the possible reasons you have identified for rejecting the planning application, prepare a new application to address each of the issues. To achieve this, you may need to:

- ▶ research construction materials to ascertain their properties and suitability
- ▶ consider sustainable construction solutions
- ▶ research corporate social responsibility towards the community.

Textbook ISBN: 9781398332874

© Hodder & Stoughton Limited, Stephen Jones, Peter Tanner 2021

All rights reserved. Apart from any use permitted under UK copyright law, no part of this publication may be reproduced or transmitted in any form or by any means, electronic or mechanical, including photocopying and recording, or held within any information storage and retrieval system, without permission in writing from the publisher or under licence from the Copyright Licensing Agency Limited. Further details of such licences (for reprographic reproduction) may be obtained from the Copyright Licensing Agency Limited, www.cla.co.uk

Photo credits: cover photo © ME Image - stock.adobe.com; p.1 © Chlorophylle/stock.adobe.com; Fig.3.1 © Sveta/stock.adobe.com; Fig.3.2 © Candy1812/stock.adobe.com; Fig.3.3 © Silent Corners/stock.adobe.com; Fig.3.4 © Aleks/stock.adobe.com; Fig.3.5 © UrbanImages/Alamy Stock Photo; Fig.3.6 © Phil Wills/Alamy Stock Photo; Fig.3.7 © Alicia G. Monedero/Shutterstock.com; Fig.3.8 © Duncan/stock.adobe.com; Table 3.1 (top to bottom): © Baharlou/stock.adobe.com, © Ian Shipley IND/Alamy Stock Photo, © Hoda Bogdan/stock.adobe.com, © Evening_tao/stock.adobe.com, © Petert2/stock.adobe.com, © Fasphotographic/stock.adobe.com, © Kim sayer/Alamy Stock Photo; Fig.3.9 © Pelvidge/stock.adobe.com; Fig.3.10 © Beataaldrige/stock.adobe.com; Fig.3.11 © Rdonar/stock.adobe.com; Fig.3.12 © FotoVoyager/E+/Getty Images; Table 3.2 (top to bottom): © Christian Delbert/stock.adobe.com, © Oleg/stock.adobe.com, © Kingspan Insulation Ltd, © Bildlove/stock.adobe.com, © Timmins Engineering & Construction Ltd, © Simon Turner/Alamy Stock Photo, © Kingspan Insulation Ltd, © Kara/stock.adobe.com; Fig.3.13 © Brizmaker/stock.adobe.com; Fig.3.14 © Laurence Berger/Shutterstock.com; Fig.3.15 © Primagefactory/123 RF.com; Fig.3.16 © KomootP/stock.adobe.com; Fig.3.17 © Ronstik/stock.adobe.com; Fig.3.18 © Pellinni/stock.adobe.com; Fig.3.19 © John Copland/Shutterstock.com; Fig.3.20 © Frank/stock.adobe.com; Fig.3.21 © Avpics/Alamy Stock Photo; Fig.3.22 © Torbay Council, Torbay, Devon, UK; Fig.3.23 © Sculpies/stock.adobe.com

City & Guilds and the City & Guilds logo are trade marks of City & Guilds Limited. City & Guilds Logo © City & Guilds 2021

'T Level' is a registered trade mark of the Institute for Apprenticeships and Technical Education. The T Level Technical Qualification is a qualification approved and managed by the Institute for Apprenticeships and Technical Education.

This page is intentionally left blank.

T-LEVELS

THE NEXT LEVEL QUALIFICATION

BUILDING SERVICES ENGINEERING FOR CONSTRUCTION CORE

Tackle the core component of your T Level with this comprehensive resource published in association with City & Guilds.

With topic coverage ranging from the principles of construction science and design to the fundamentals of gas, plumbing and electrotechnical engineering, this book provides complete coverage of the Building Services Engineering for Construction qualification's core units and will equip you with the skills you need to shape your career.

- ➔ Break down complex topics with summary tables and hundreds of images and artworks
- ➔ Apply your knowledge in real-world case studies and discover some of the dilemmas you can expect to face in the workplace
- ➔ Recap knowledge and understanding with 'Key terms' and 'Test yourself' features, as well as a detailed glossary
- ➔ Prepare for your exams and the employer-set project using practice questions and project practice exercises
- ➔ Develop the functional skills you need to thrive in the industry with English and maths exercises
- ➔ Understand how to avoid hazards and minimise risk with regular health and safety reminders
- ➔ Hone core skills with expert authors Mike Jones, Stephen Jones, Tom Leahy, Peter Tanner and David Warren, who draw on their extensive teaching and industry experience



Boost

This title is also available as an **eBook** with **learning support**.

Visit hoddereducation.co.uk/boost to find out more.

'T Level' is a registered trade mark of the Institute for Apprenticeships and Technical Education. The T Level Technical Qualification is a qualification approved and managed by the Institute for Apprenticeships and Technical Education.

HODDER EDUCATION

t: 01235 827827

e: education@hachette.co.uk

w: hoddereducation.co.uk